

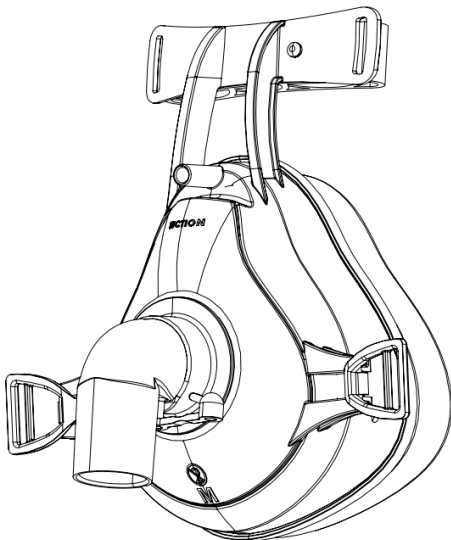

“LUMENA”

Aerosol Minimizing NIV Mask for Adults



Instructions For Use

Please read the following operating instructions carefully. They are a part of the product and should be available at all times.

Mask Description

The “Lumena” aerosol minimizing mask is an interface accessory meant to be connected to a ventilation device providing air flow for patients in need of Non-Invasive Ventilation (NIV), generating the required pressure for the therapy while minimizing potentially harmful emissions into the environment.

The mask is comprised of several components, as shown in the following figure.

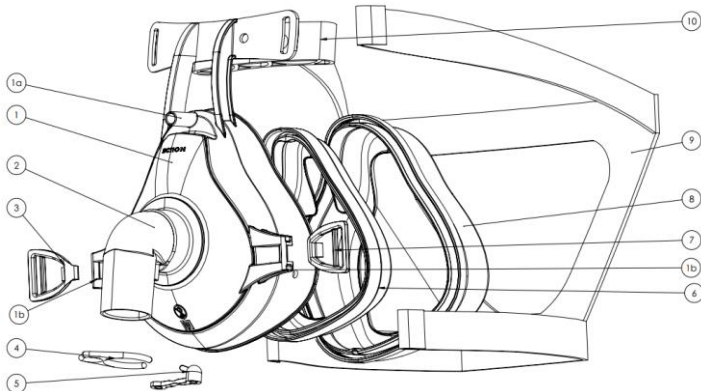

Figure Index

- | | | |
|---------------------------------|--|--------------------|
| ① Mask Frame, containing: | ①a Vacuum source suction connection port. For use with wall suction / portable vacuum machine using a 28Fr suction tube for maintaining negative pressure in the mask's outer layer. | |
| | ①b Headgear Clip Loops | |
| ② Elbow | ⑤ Oxygen port cap | ⑧ Outer cushion |
| ③ Quick-release attachment Clip | ⑥ Inner cushion | ⑨ Headgear strap |
| ④ Suction & inlet tubes gripper | ⑦ Attachment Clip | ⑩ Forehead cushion |

Kit Contents

1. “Lumena” mask
2. Headgear
3. Hose-Tube grippers (X2)
4. Corrugated suction tube (3 meter) – optional

Additional Accessories Required

1. Corrugated suction tube (3 meter)
2. Auxiliary AAV – Open / Close threshold 4 cm H₂O (for ventilators without an adequate alarm)
3. Expiration valve (for single limb circuits)

Intended Use

The “Lumena” is a disposable, single-patient-use, adult Oro-Nasal mask intended to provide a patient interface for application of Non-Invasive Ventilation (NIV) while minimizing dispersion of bio-aerosols and aerosolized drugs into the surrounding. The mask is designed as an accessory for continuous single or double limb ventilators which have adequate alarms and safety systems for ventilator failure, or an auxiliary safety mechanism such as a Whisper Valve.

Warnings

- Do Not use the "Lumena" mask with patients not able to remove it independently, or with patients suffering from regurgitative conditions or a tendency to vomit. Doing so may cause asphyxiation.
- The mask is a non-vented mask. Always use an expiration valve in single limb setups – See “Use Setups” for further elaboration.
- In case of mask readjustment, or when removal of the mask is required, lower the ventilation pressure prior to mask removal to ensure safe adjustment.
- Use the "Lumena" mask only within the therapy pressure ranges indicated (i.e., 4-30 cmH₂O); Exceeding said limits may lead to CO₂ rebreathing / leakages.
- When using the "Lumena" mask with a device without an adequate alarm, an auxiliary Anti-Asphyxiation Valve (AAV) must be connected to prevent rebreathing in the event of ventilator failure.
- Patients with limited spontaneous respiration must be supervised at all times. The appropriate negative pressure / leak alarm on the ventilation device must be activated.
- Patients with obstructive and restrictive lung diseases should be examined on an individual basis while using the "Lumena" mask (e.g., with regard to the rebreathing of CO₂).
- Do not place the mask over the patient’s face for a prolonged period unless the therapy unit is switched on. Doing so may increase the risk of CO₂ rebreathing or result in an adverse effect on the therapy quality.
- When using the “Lumena” mask with an automatic trigger ventilator, exercise extra vigilance for patient ventilator asynchrony.
- Discontinue use of the mask if the patient has ANY adverse reaction to the use of the mask such as skin damage / irritation.
- There is a risk of fire associated with Oxygen equipment and therapy. Do not use near sparks or open flames.
- If oxygen is used, the oxygen flow must be turned off when the mask is not in use, so that unused oxygen does not accumulate within the device enclosure and create a risk of fire.
- When, and if applied, use only sealing gels or lubricants that are labeled “compatible with O₂”.
- During oxygen usage, do not smoke in the vicinity of the device.
- Do not lubricate fittings, connections, tubing, or other accessories to avoid the risk of fire and burns.
- At a fixed flow rate of supplemental oxygen flow, the inhaled oxygen concentration will differ based on patient breathing pattern, leak rate, pressure settings used and mask selection.

Precautions

- The “Lumena” mask is intended for short-term use of up to 14 days. Do not use beyond said limit.
 - Do not use the device if the “Use by” date indicated on the package label has passed.
 - The device is intended for single patient use only. DO NOT reuse, reprocess or sterilize. Reuse, reprocessing or sterilization may compromise the structural integrity of the device and / or lead to device failure, which in turn, may result in patient injury, illness or death. Reuse, or reprocessing may create a risk of contamination of the device and / or patient infection or cross-contamination, including, but not limited to the transmission of infectious disease(s) from one patient to another. Contamination of the device may lead to injury, illness or death of the patient.
 - Inspect the mask package and contents to verify that no damage has occurred as a result of shipping, handling, and / or storage, and that no parts are missing from the pack. If any parts are noted as missing, DO NOT USE the device. Retain the package with the contents and notify your Inspir Labs Ltd. representative.
 - In case of irritation from headgear, first, take off and readjust or try a different mask size. If irritation persists, cease usage of the mask.
 - In case the mask does not fit, use the dimensions specified in Specifications section and refit a different size mask.
 - Ensure that the suction tube is new and not reused or blocked for any reason.
 - The kit contains small parts that can pose a choking hazard, keep away from children under 5 years.
-

Contraindications

- Functional disturbance of the lower esophageal sphincter (lower sphincter of the esophagus)
 - Excessive regurgitation (reflux of stomach contents into the esophagus)
 - Cough reflex disturbance
 - Hiatus hernia (diaphragmatic hernia)
 - Anesthetic or sedation
 - Open facial wounds
 - Hemodynamic or cardiorespiratory instability
 - Unconsciousness
 - Claustrophobia, anxiety
 - Facial deformation or deformation of the end of the nasopharynx
 - Thick beard or other obstructions to adjusting and sealing the mask
 - Barotraumas
 - Fresh facial, esophageal or stomach operations
 - Taking medication that can cause vomiting
 - Necessity for immediate intubation
-

Potential Side Effects

The following side effects may occur:

- Nasal congestion
- Dry nose
- Dry mouth in the morning
- Sinus pressure
- Chest pains
- Breathlessness
- Flatulence
- Headaches
- Irritation of the conjunctiva
- Irritating noises during exhalation
- Pressure sores on the face
- Reddening of the skin

Operations

Compatible Devices and Accessories

The "Lumena" mask can be combined with all units designed for carrying out the therapies described under "Intended Use". Note that if unsuitable device combinations are used, the actual pressure in the mask may not correspond to the required therapy pressure.

Use Set-Up

The "Lumena" Mask is best used in the following circuitry:

Dual Limb:

Dual limb with Bacterial-Viral filter

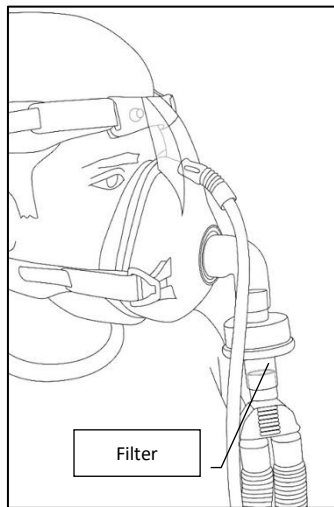

Dual limb no Bacterial-Viral filter – For integral filtering ventilators

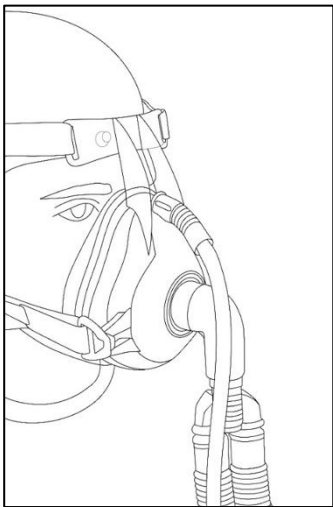

Single Limb:

Note: Both single limb set-ups require a Bacterial-Viral filter and an expiration device.

Single limb with AAV model

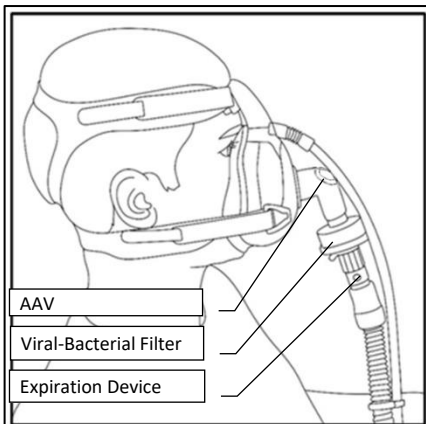

Single limb no AAV

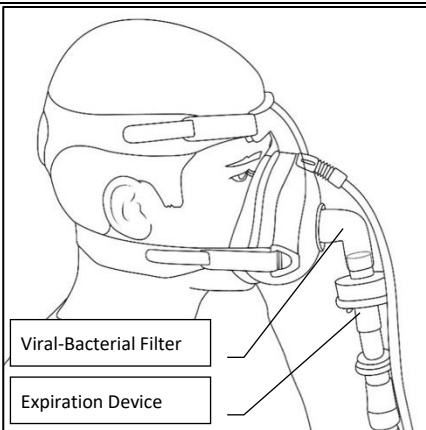

Note: The Standard elbow (Blue Elbow) model must be used, with either ventilator, with adequate alarms or a circuit that contains an AAV to provide access to room air in case of ventilator malfunction

Wearing the Mask



Caution! Always connect the expiration device downstream to the filter! Failing to do so may result in contamination of the environment.

Leave one of the lower headgear clips free.

1. Make sure the oxygen port cap is tightly secured.

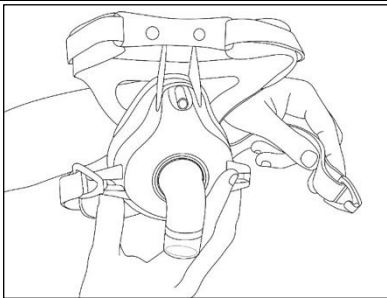

Place the headgear over the patient's

2. head and hook the headgear free clip back onto the mask.

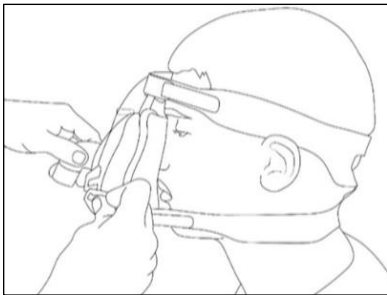

3. Adjust the headgear so that the mask seals on the face but is not too tight.

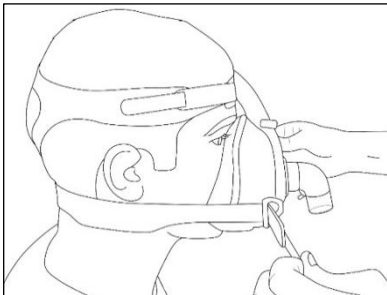

Exhaled Air System

Warning! The "Lumena" mask **does not have its own exhalation system!** It may only be used in combination with therapy devices or circuits which have an **active exhalation valve!** There is otherwise the risk of CO₂ rebreathing and suffocation.

Therapy Pressure Ranges

The "Lumena" mask is meant for usage in a particular therapy pressure range (4-30 cmH₂O) only.

Connecting the Hose to the Therapy Unit

Push the hose of your therapy unit into the machine outlet as shown in the figure below. Ensure that the connection to the hose is secure and airtight. The connection must not be loosened by the therapy pressure.

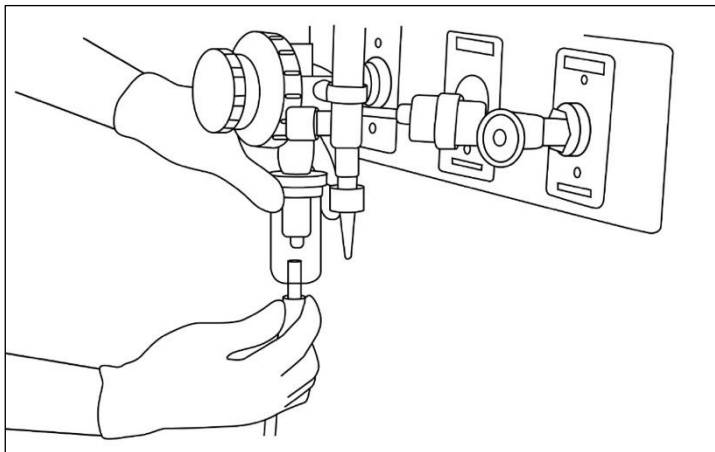

Connecting the Suction Tube to the "Lumena" Mask

Connect the other side of the suction tube to the suction port of the "Lumena" mask as shown in the Figure. Ensure that the connection to the port is secure and airtight.

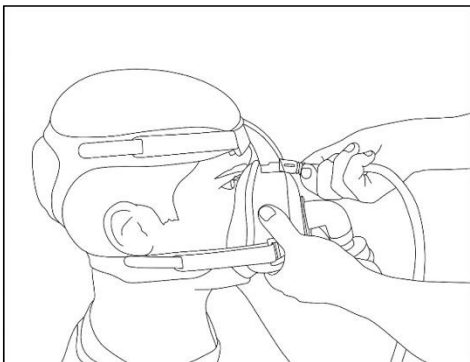

Connecting the Hose to the "Lumena" Mask

When using a set-up with a Bacterial-Viral filter, connect the filter to the Elbow as shown in the Figure.



Caution! - Do not connect the filter upside down. Push the Hose onto the mask elbow/filter and ensure the hose fits tightly.

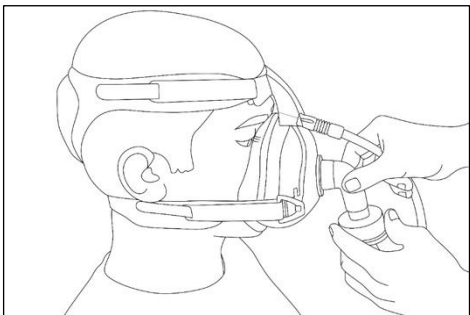

Humidifier

The "Lumena" mask can be used with both cold and warm-air humidifiers. Never set the humidification level so high that condensation forms in the air hose or in the mask. Follow the instructions for use of your humidifier and therapy unit.

Mask Removal

To remove the mask, pull the Blue quick release clip to the side, and pull the mask and headgear up and over the patient's head.

Cleaning

The "Lumena" is a single patient disposable mask that should be replaced in case it is severely soiled with the patient's secretions. However, if it is only lightly soiled, the mask may be cleaned by wiping using soap and water. Do not disassemble the mask when cleaning.

Always follow the cleaning instructions. Some cleaning products may damage the mask, its parts and their function, or leave harmful residual vapors.

Disposal

After use, this product may be a potential biohazard. Handle and dispose of in accordance with accepted medical institutional practice and applicable local, state and federal laws and regulations.

Sizing Table

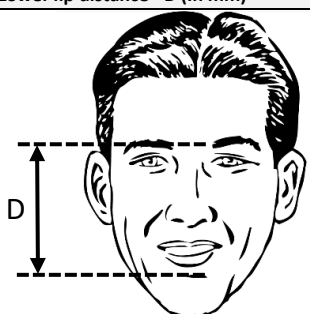
Size	Nose bridge to Lower lip distance - D (In mm)	
Small	$80 < D < 90$	 <p>The diagram shows a front view of a human face. A vertical double-headed arrow labeled 'D' indicates the distance from a horizontal dashed line across the bridge of the nose to another horizontal dashed line across the lower lip.</p>
Medium	$90 < D < 105$	
Large	$105 < D < 120$	

Troubleshooting

Malfunction	Cause	Solution
Painful pressure on the face	Mask worn too tight	Loosen headgear slightly. Adjust position of forehead support
Draught in the eyes	Mask is worn too loose	Tighten headgear slightly. Adjust position of forehead support
	Mask size does not fit	Use mask of different size
Therapy pressure is not reached	Mask is not adjusted correctly	Adjust headgear. Adjust position of forehead support
	Mask does not fit the patient	Replace mask with larger/smaller size
	Hose system is not airtight	Check hose connections to mask and ventilation machine
No Suction	Suction tube blockage	Replace suction tube
	Loose suction tube connection	Reattach suction tube to connector, check that all connectors are properly connected
	Insufficient suction source	Replace the suction source

Specifications

Dimensions	Small:	(H) 67.50mm x (L) 160.40 x (W) 120.00
	Medium:	(H) 68.50mm x (L) 174.75 x (W) 124.00
	Large:	(H) 69.00mm x (L) 182.50 x (W) 134.00
	Wide:	(H) 68.50mm x (L) 160.40 x (W) 120.00
Weight (Typical):		170 grams
Therapy pressure range:		4 to 30cmH ₂ O
Suction flow range:		>25L/min
Hose connector: Cone complying with EN ISO 5356-1 non-vented variants		Ø 22mm (male)
		Ø 22mm (female)
Width of headgear clips:		25mm
Temperature range	Operation:	15°C (59°F) to 40°C (104°F)
	Storage:	0°C (32°F) to 40°C (104°F)
Flow resistance	At 50 L/Min:	0.8cmH ₂ O
	At 100 L/Min:	2.7cmH ₂ O
Useful Life time:		14 days
Note: All mask components are NOT made with natural rubber latex		

Pressure / Flow Characteristic Curve

Pressure - Flow At Various Input Pressures

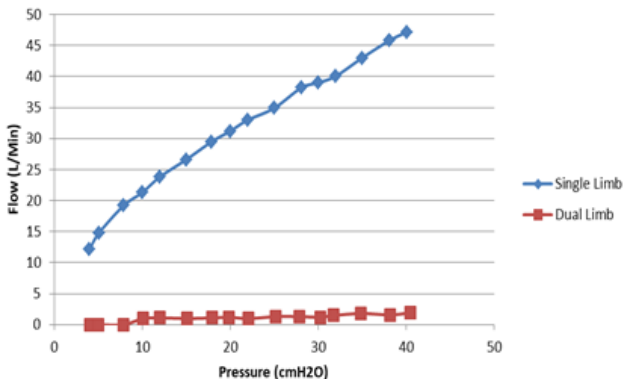

Warranty

Inspir Labs Ltd. (“**Inspir**”) provides its customer with a limited warranty on new and genuine products purchased from Inspir in accordance with Inspir’s warranty policy applicable to the product in question (the “**Warranty Policy**”) and in accordance with the warranty periods as listed below. The Warranty Policy includes, amongst others, limitations and exceptions to the warranty and procedures for exercising the warranty. To receive the detailed Warranty Policy, please contact Inspir at info@inspirlabs.com. In the event of a claim under warranty, please contact your authorized Inspir dealer.

If third-party items are used, functional failures may occur and fitness for use may be restricted. Biocompatibility requirements may also not be met.

Product

“Lumena” mask, Headgear, Tube grippers and Suction tube (if exists in the unit package)

Period of Warranty

2 years from the date of purchase OR until the Expiration Date, whichever comes first

Symbols Used in the Labels



Caution: Federal law restricts this device to sale by or on the order of a physician



Consult instructions for use



Not made with natural rubber Latex



Caution



Do not Reuse



Catalogue number



Temperature limit



Batch code



Keep away from direct sunlight



Use-by date



Medical device



Single patient multiple use



Do not use if package is damaged



Non-Sterile



Manufacturer: Inspir Labs Ltd.

1 Shenkar Street, Herzliya 4672501, Israel

Email: info@inspirlabs.com

Website: <https://www.inspirlabs.com>